

Data Sheet



Article number: 201119267

Description: E+G Handwheel
GN 323-80-K12-R

Measures

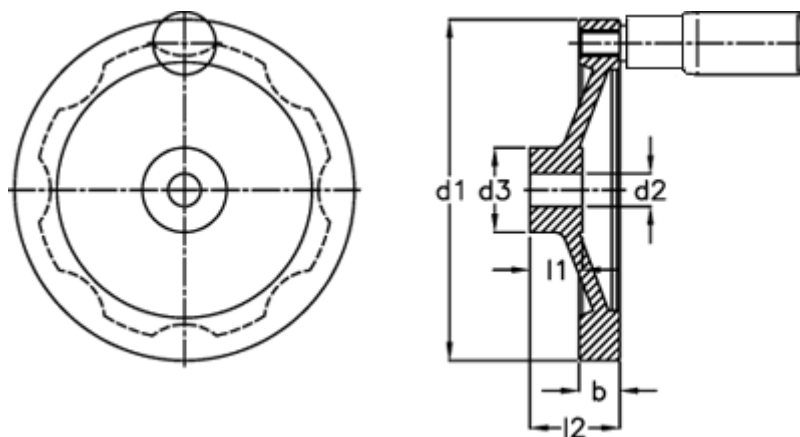

b = 13.0

d1 = 80

d2 H7 = 12

d3 = 26

Handle = 16

l1 = 16

l2 = 26